

PRODUCT TECHNICAL DATASHEET

BI/001PE

Brushless 

Intensive use 

High Speed 

Digital Encoder 

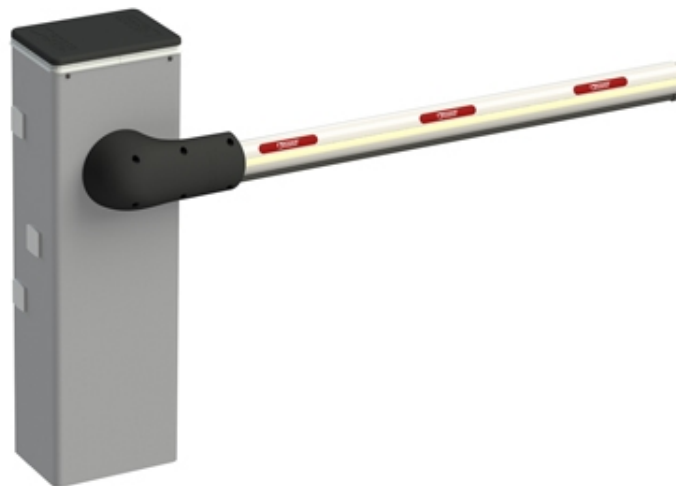

CODE	DESCRIPTION	PCS/PALLET
BI/001PE	Automatic Barrier BRUSHLESS 36V DC, rapid version, super intensive use up to 3 meters, with operator and and built in digital control panel and absolute encoder on board; parking version.	6

PRODUCT TECHNICAL SPECIFICATIONS	
Barriers	Up to 3 mt long
Power line supply	230V AC - 50Hz
Motor power supply	36V DC
Electrical absorption	max 15A
Power rating	450W
Frequency of use	Super intensive use
Torque	10 - 200 N m
Operating temperature	- 20 + 55 C°
Protection level	IP54
Reductor Type	Irreversible
Opening time at 90°	2 ÷ 4 (sec)
Onboard control unit	CTRL/P Digital Controller 36V DC
Encoder	Digital native encoder + magnetic digital SENSORED, 4096 PPR
Accessories power supply	24V DC
Release system	European Key cylinder
Batteries recovery	Available (optional)
BUS synchronization Master/Slave	No
Operating cycles per day (opening/closing - 24 hours no stop)	8000 cycles
Maximum dimension product in mm (L x W x H)	380 x 270 x 1237

Product weight packed (Kg)	72
Number items per pallet	6

PRODUCT DIMENSIONS AND PREPARING FOR INSTALLATION

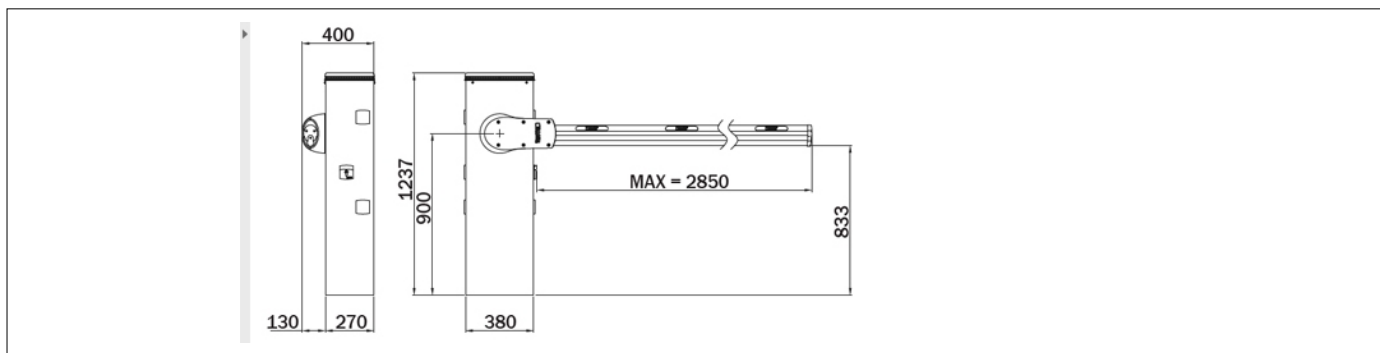

DIMENSIONS

PRODUCT ACCESSORIES



BA/90/2
White painted aluminum rod, 2 meters long, with LED cover profile and impact resisteng rubber profile.



BA/90/3
White painted aluminum rod, 3 meters long, with LED cover profile and impact resisteng rubber profile.



JNT/BA/90
Internal boom bar joint in anodized aluminum including fixing screws for bars BA/90.

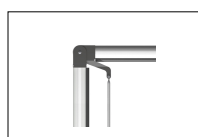

SND/BA/90/DW
Articulated joint 90° with lower tie rod for boom arms BA/90.

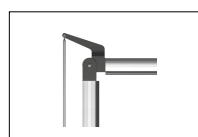

SND/BA/90/UP
Articulated joint 90° with upper tie rod for boom arms BA/90.



ACS/BA/60
Break-away system for barrier, compatible only with BA/60/3 boom arm.



ACS/BA/68
Break-away system for barrier, compatible with BA/68/3 and BA/68/4 boom arm.

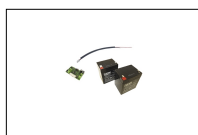

BI/BAT/KIT
Kit for emergency batteries charger for brushless digital controller CTRL 36V DC with plug-in card, with 2 recovery batteries 12V DC, 4.5 Ah. Kit for BIONIK barrier.



BI/BCHP
Plug-in card, batteries charger, for brushless digital controller CTRL 36V DC, without recovery batteries, for BIONIK barrier.



BT12V45
Battery 12V 4.5 Ah.



B71/PBX36/BOX
Battery chargers with solar panels for powering Brushless digital controllers at 36V DC in network mode



B71/PBX36/BOX/115
Battery chargers with solar panels for powering Brushless digital controllers at 36V DC in network mode



B71/PBX/BOX
Battery chargers with solar panels for powering Brushless digital controllers in FULL SOLAR mode

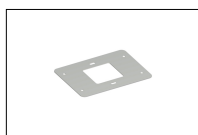

KT230
Fixing plate with stay bolts and screws for BI/001PE - BI/001PC - BI/004HP - BI/006.

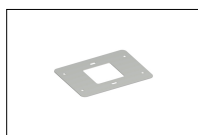

KT230/IS
Fixing plate, inox AISI 304 version, with stay bolts and screws for BI/001PE - BI/001PC - BI/004HP - BI/006.



CRA/BAR
Post for photocells G90/F2ES - G90/F4ES - for spaced installation on a barrier cabinet (+23cm).



B73/EXP
Signal status board, 2 output for CTRL - CTRL/P

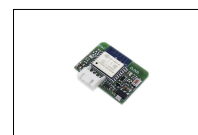

B74/BCONNECT
Module Wi-Fi B-CONNECT - Management and programming system in IP web mode, via P2P hot spot Wi-Fi connection for 36V brushless digital controller (EDGE1 - CTRL - CTRL/P - B70/1DCHP).



SP/72/01
Spring diameter 72 mm for barriers.



DLD1/24
Loop detector for 1 loop, 2 output, 24V AC/DC.



DLD2/24
Loop detector for 2 loop, 2 output + output alarm, 24V AC/DC.

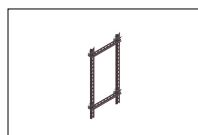

KT239
Kit DIN rail with magnetic support.



KT242
Cable passage kit, with magnetic support, for barriers.



ALED/6C
Luminous led cord of 6 meters with connection cable for boom arms.



R99/BASB20
Pack of 20 stickers for barrier.



R99/BASB40
Pack of 40 stickers for barrier.